

General

The new "ECOPLUS", cylinder manufactured according to ISO 15552 is the result of the experience made on the 1319-1320-1321 series.

The new family comprises two sub categories:

ECOPLUS (●) manufactured with high resistance technopolymer end caps, the same used on the 1380-1381-1382 series.

ECOPLUS (●) manufactured with aluminium die cast end caps. The barrel is common to both series and includes, on three sides, 2 grooves to suit, without the need of adaptors, the 1580 slim series magnetic sensors.

The piston design is based on the very well tested design of the 1380 series therefore comprising two half piston manufactured in acetylic resin which ensure very good rod guide and already include the cushion cones. The piston seals are NBR as standard but are also available in polyurethane upon request (both for **ECOPLUS** (●) and **ECOPLUS** (●)). The magnet is fitted between the two half pistons.

The units can be mounted using the threaded holes in the end cap mounting screws or via the 1380 series accessories. (see cylinder mountings section in the general catalogue) with the exclusion of the intermediate trunnion which for this series is codified as 1386.*12F

The possibility of choosing between tecnopolimer and aluminium end caps ensure the possibility of choosing the best product for the application.

Construction characteristics

End plates	Series 1386 ÷ 1388: Higt resistant termoplastic material	Series 1396 ÷ 1398: Aluminum Die Cast
Rod	C43 chromed steel or stainless steel	
Barrel	aluminium alloy anodised	
Rod-guide bushing	self-lubricating sintered bronze	
Half-Piston	Acetylic resin	
Seal	NBR rubber or polyurethane upon request (see the ordering code)	
Rod-seal	Polyurethane	
Cushion adjusting screws	Brass	

Technical characteristics

Fluid	filtered and preferably lubricated air or non (If lubricated the lubrication must be continuous)
Max. pressure	10 bar
Operating temperature	-5° C ÷ +70°C
Bore	Ø 32 - 40 - 50 - 63 - 80 - 100
Cushioning lenght	mm 27 - 31 - 31 - 37 - 40 - 44

"Attention: Dry air must be used for application below 0°C"

Standard strokes (for all diameters)

from 0 to 150, every 25 mm
from 150 to 500, every 50 mm
from 500 to 1000, every 100

Stroke tolerance (ISO 15552)

Bore	Stroke	Tolerance
32 - 40 - 50	up to 500	+2 0
	over 500 up to 1000	+3.2 0
63 - 80 - 100	up to 500	+2.5 0
	over 500 up to 1000	+4 0

Drawing

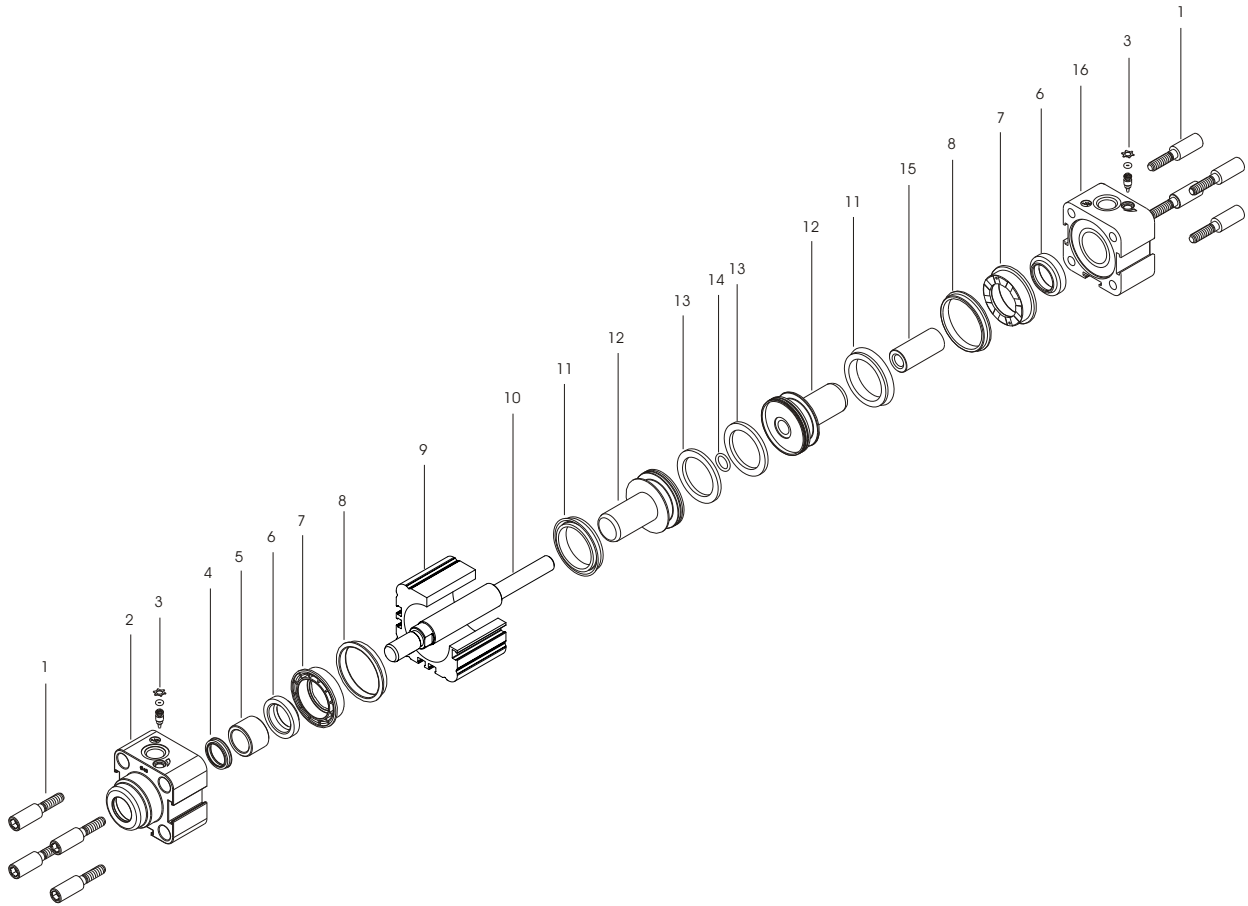

Pos	Description	N. Pieces
1	Tie rod nut	8
2	Front end cover	1
3	Cushion adjustment pin	2
4	Rod seal	1
5	Rod - guide - bushing	1
6	Cushion seal	2
7	Cushion seal cup	2
8	Cover seal	2
9	Barrel	1
10	Rod	1
11	Piston seal	2
12	Half piston	2
13	Magnet	*
14	Seal	1
15	Piston rod nut	1
16	Rear and cover	1

* n° 1 for Ø 32, n° 2 for other bores

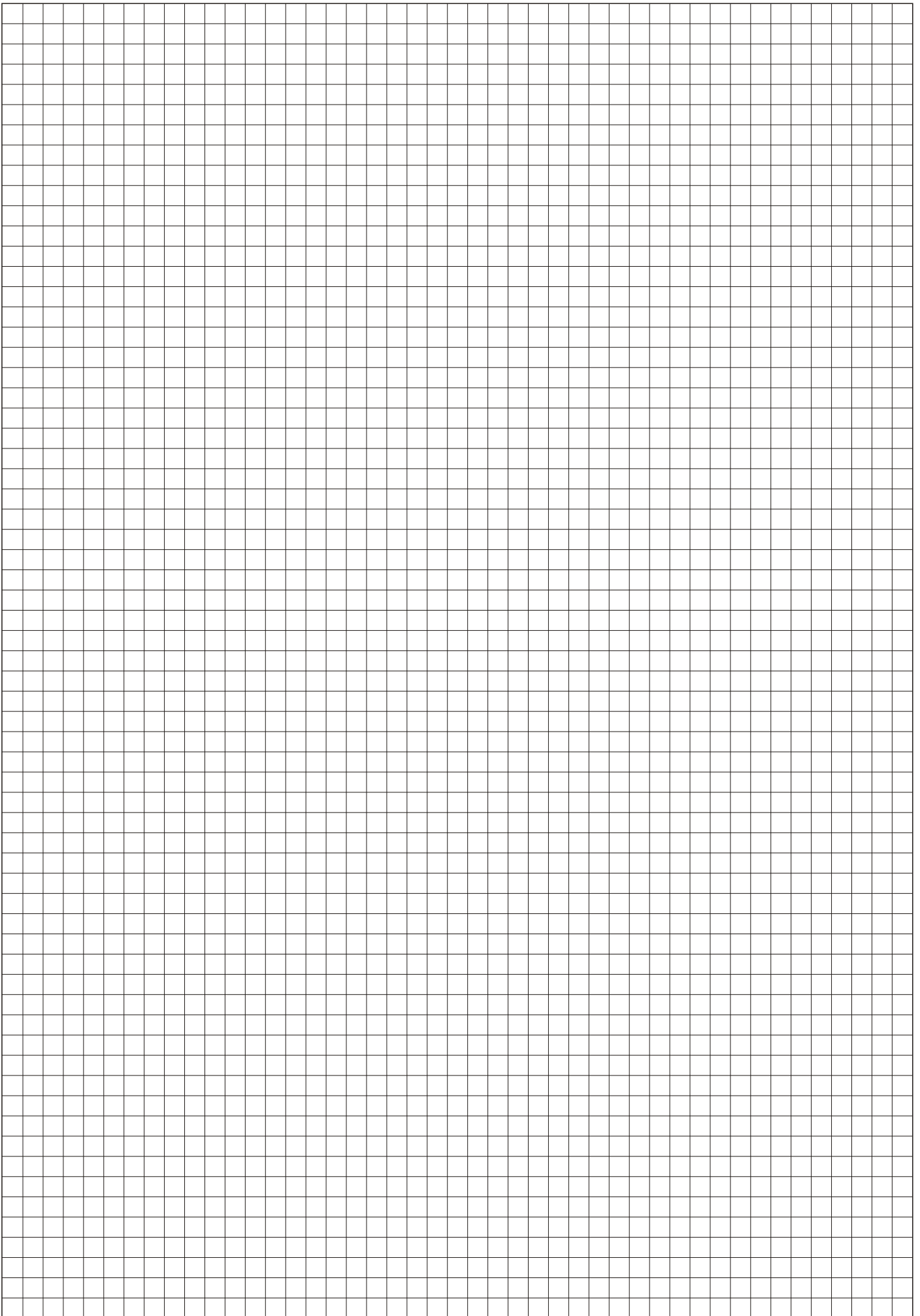

Basic version "01"

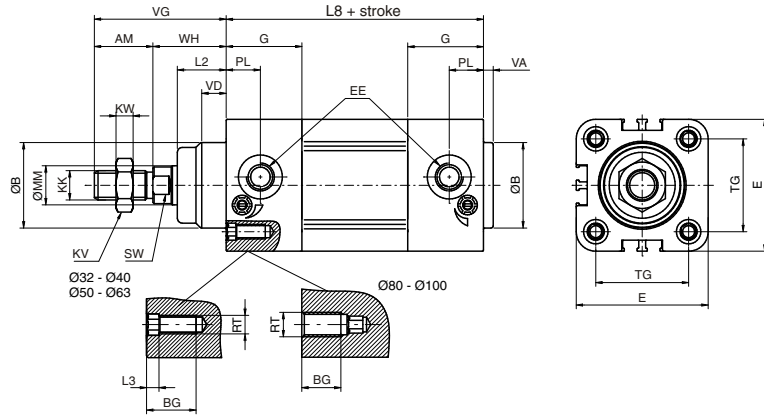

Ordering code

- 1386.Ø.stroke.01** Magnetic chromed rod
- 1387.Ø.stroke.01** Magnetic chromed stainless steel rod
- 1388.Ø.stroke.01** Non magnetic

This is the configuration representing the basic cylinder according to ISO -VDMA standards. It can be directly anchored on machine parts using the 4 threads on the end cover screws. For other applications see "Cylinder section" on the general Catalogue, where different types of attachments are shown.

Push/pull version "02"

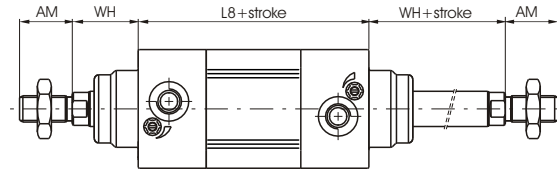

Ordering code

- 1386.Ø.stroke.02** Magnetic chromed rod
- 1387.Ø.stroke.02** Magnetic chromed stainless steel rod
- 1388.Ø.stroke.02** Non magnetic

Tandem push with common rod "G"

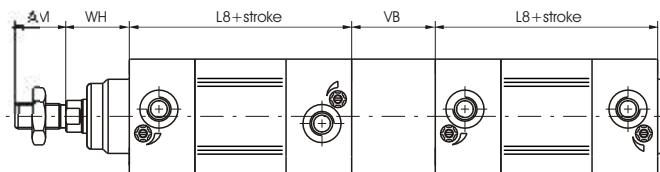

Ordering code

- 1386.Ø.stroke.G** Magnetic chromed rod
- 1387.Ø.stroke.G** Magnetic chromed stainless steel rod
- 1388.Ø.stroke.G** non magnetic

Tandem push with independent rods "F"

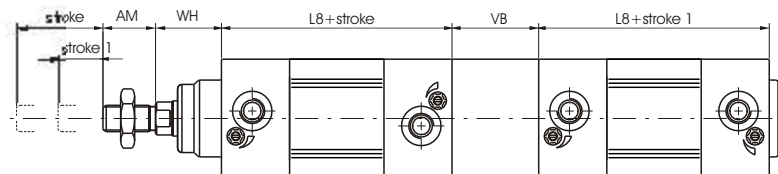

Ordering code

- 1386.Ø.stroke.stroke1.F** Magnetic chromed rod
- 1387.Ø.stroke.stroke1.F** Magnetic chromed stainless steel rod
- 1388.Ø.stroke.stroke1.F** non magnetic

Opposed tandem with common rods - "D"

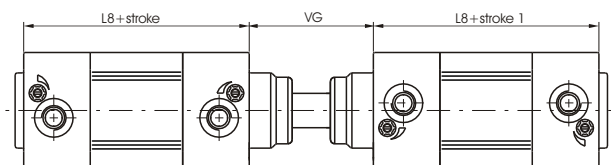

Ordering code

- 1386.Ø.stroke.stroke1.D** Magnetic chromed rod
- 1387.Ø.stroke.stroke1.D** Magnetic chromed stainless steel rod
- 1388.Ø.stroke.stroke1.D** non magnetic

Tandem with opposed rods - "E"

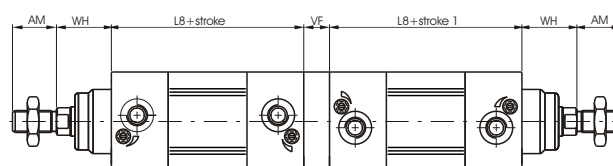

Ordering code

- 1386.Ø.stroke.stroke1.E** Magnetic chromed rod
- 1387.Ø.stroke.stroke1.E** Magnetic chromed stainless steel rod
- 1388.Ø.stroke.stroke1.E** non magnetic

Variants

Version with polyurethan seals

Ordering code

1386.(87.88) Ø.stroke._ _ P

Table of dimensions

Bore	32	40	50	63	80	100	
AM	22	24	32	32	40	40	
B (d 11)	30	35	40	45	45	55	
BG	16	16	18	18	16	16	
E	46	54	65	77,5	95,5	115,5	
EE	G 1/8"	G 1/4"	G 1/4"	G 3/8"	G 3/8"	G 1/2"	
G	29	31	33	36	40	44	
KK	M10X1,25	M12X1,25	M16x1,5	M16x1,5	M20x1,5	M20x1,5	
KV	17	19	24	24	30	30	
KW	6	7	8	8	9	9	
L2	16	20	25	25	32	35	
L3	4	4	5	5	/	/	
L8	94	105	106	121	128	138	
MM	12	16	20	20	25	25	
PL	13	14	14	16	16	18	
RT	M6	M6	M8	M8	M10	M10	
SW	10	13	17	17	22	22	
TG	32,5	38	46,5	56,5	72	89	
VA	4	4	4	4	4	4	
VB	33	41	51	51	65	71	
VD	8	10	12	12	15	16	
VF	12	12	16	16	20	20	
VG	48	54	69	69	86	91	
WH	26	30	37	37	46	51	
Weight	stroke 0	470	590	1020	1320	2090	3010
gr.	every 10 mm	29	40	57	66	96	112

Basic version "01"

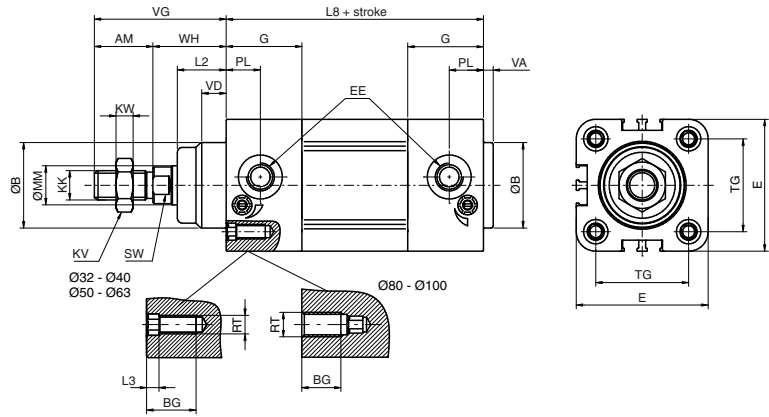

Ordering code

- 1396.Ø.stroke.01** Magnetic chromed rod
- 1397.Ø.stroke.01** Magnetic chromed stainless steel rod
- 1398.Ø.stroke.01** Non magnetic

This is the configuration representing the basic cylinder according to ISO -VDMA standards. It can be directly anchored on machine parts using the 4 threads on the end cover screws. For other applications see "Cylinder section" on the general Catalogue, where different types of attachments are shown.

Push/pull version "02"

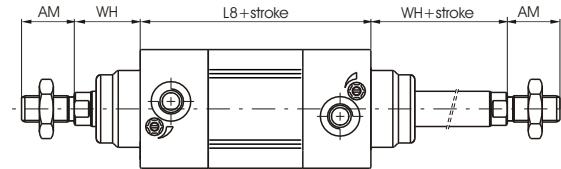

Ordering code

- 1396.Ø.stroke.02** Magnetic chromed rod
- 1397.Ø.stroke.02** Magnetic chromed stainless steel rod
- 1398.Ø.stroke.02** Non magnetic

Tandem push with common rod "G"

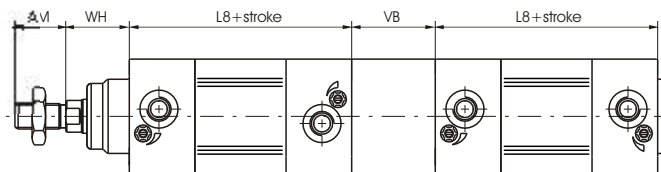

Ordering code

- 1396.Ø.stroke.G** Magnetic chromed rod
- 1397.Ø.stroke.G** Magnetic chromed stainless steel rod
- 1398.Ø.stroke.G** non magnetic

Tandem push with independent rods "F"

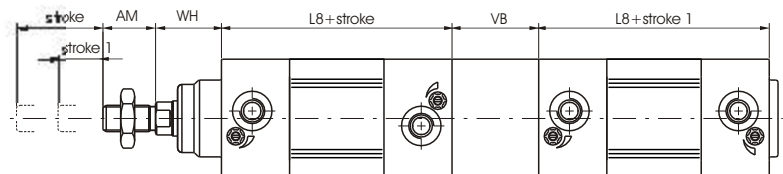

Ordering code

- 1396.Ø.stroke.stroke1.F** Magnetic chromed rod
- 1397.Ø.stroke.stroke1.F** Magnetic chromed stainless steel rod
- 1398.Ø.stroke.stroke1.F** non magnetic

Opposed tandem with common rods - "D"

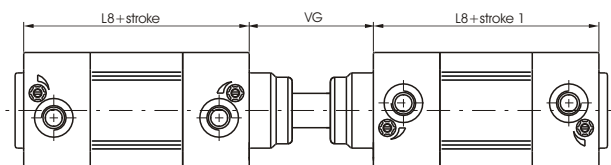

Ordering code

- 1396.Ø.stroke.stroke1.D** Magnetic chromed rod
- 1397.Ø.stroke.stroke1.D** Magnetic chromed stainless steel rod
- 1398.Ø.stroke.stroke1.D** non magnetic

Tandem with opposed rods - "E"

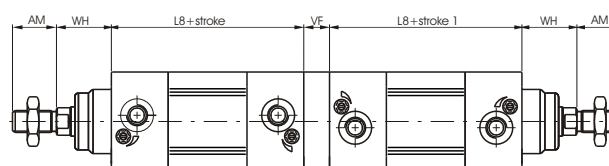

Ordering code

- 1396.Ø.stroke.stroke1.E** Magnetic chromed rod
- 1397.Ø.stroke.stroke1.E** Magnetic chromed stainless steel rod
- 1398.Ø.stroke.stroke1.E** non magnetic

Variants

Version with polyurethan seals

Ordering code

1396.(97.98) Ø.stroke._ _ P

Table of dimensions

Bore	32	40	50	63	80	100	
AM	22	24	32	32	40	40	
B (d 11)	30	35	40	45	45	55	
BG	16	16	18	18	16	16	
E	46	54	65	77,5	95,5	115,5	
EE	G 1/8"	G 1/4"	G 1/4"	G 3/8"	G 3/8"	G 1/2"	
G	29	31	33	36	40	44	
KK	M10X1,25	M12X1,25	M16x1,5	M16x1,5	M20x1,5	M20x1,5	
KV	17	19	24	24	30	30	
KW	6	7	8	8	9	9	
L2	16	20	25	25	32	35	
L3	4	4	5	5	/	/	
L8	94	105	106	121	128	138	
MM	12	16	20	20	25	25	
PL	13	14	14	16	16	18	
RT	M6	M6	M8	M8	M10	M10	
SW	10	13	17	17	22	22	
TG	32,5	38	46,5	56,5	72	89	
VA	4	4	4	4	4	4	
VB	33	41	51	51	65	71	
VD	8	10	12	12	15	16	
VF	12	12	16	16	20	20	
VG	48	54	69	69	86	91	
WH	26	30	37	37	46	51	
Weight	stroke 0	550	690	1200	1590	2500	3670
gr.	every 10 mm	29	40	57	66	96	112

Sensor c/w 2.5 m. cable



Weight gr. 27

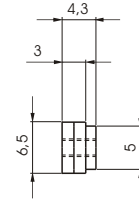
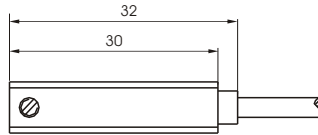

Sensor c/w M8 connector (300 mm cable)



Weight gr. 15

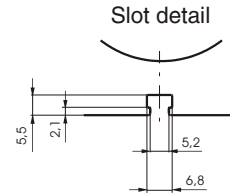
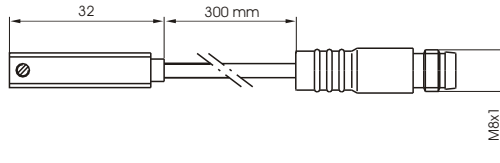

Ordering codes

Cylinders and Microcylinders

1580.U	Reed bulb sensor with led and 2.5 m cable
1580.UAP	Reed bulb sensor with led and 2.5 m cable (3 wires)
1580.HAP	PNP sensor Hall effect with led and 2.5 m cable
MRS.U	Reed bulb sensor with led and connector
MRS.UAP	Reed bulb sensor with led and connector (3 wires)
MHS.P	PNP sensor Hall effect with led and connector

Cable

MC1	M8 in line connector with 2.5 m cable (2 wires)
MC2	M8 in line connector with 5 m cable (2 wires)
MCH1	M8 in line connector with 2.5 m cable (3 wires)
MCH2	M8 in line connector with 5 m cable (3 wires)

Diagrams and connections

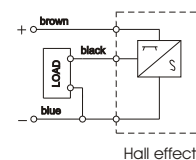
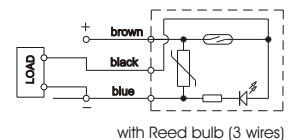
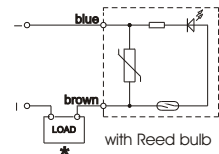

Technical characteristics	1580.U	1580.UAP	MRS.U	MRS.UAP	1580.HAP	MHS.P
Type of contact	N.A.					
Maximum current (pulses of 0,5 sec.)	0,2A					0,2A
Maximum permanent current	0,2A					0,2A
Maximum permanent power	6VA					4W
Voltage range A. C.	3 ÷ 30V	24V	3 ÷ 30V	/		
Voltage range D. C.	3 ÷ 30V	24V	3 ÷ 30V	12÷30V		
Working temperature	-20° C ÷ 70°C					
Maximum voltage drop	<3V	0V	<3V	0V	<3V	
Cable section	2x0,14	3x0,14	2x0,14	3x0,14		
Degree of protection	IP 65					
Connecting time	0,5 ms					0,8 µs
Disconnecting time	0,1 ms					0,3 µs
Average working period	10 ⁷					10 ⁹
Repetition of intervention point	± 0,1					

NOTE : pay attention to the connected loads which should not exceed the recommendation



D. NW. 51/GB - 02/2009
PRINTED IN ITALY - 02/2009

PNEUMAX S.p.A.
24050 LURANO (BG) - Italy
Via Cascina Barbellina, 10
Tel. 035/4192777
Fax 035/4192740
035/4192741
<http://www.pneumaxspa.com>
pneumax@pneumaxspa.com

